

# Catalogue

AL5



ALUMINIUM FACTORY

AL5



ALUMINIUM FACTORY

TABLE OF CONTENTS

**SECTION 01** WINDOW PROFILE

**03**

AL5



ALUMINIUM FACTORY

# Window

*profile*

SECTION 01

---

№

**VP-410**

**S**=3,492 CM<sup>2</sup>  
**M**=0,946 КГ/М  
**D**=127 MM

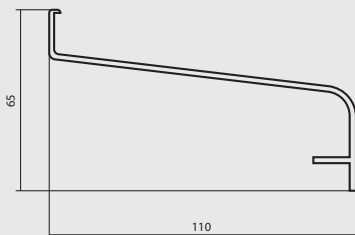
**VP-4812**

**S**=8,112 CM<sup>2</sup>  
**M**=2,198 КГ/М  
**D**=104 MM

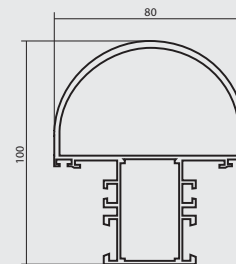
**VP-48104**

**S**=0,955 CM<sup>2</sup>  
**M**=4,84 КГ/М  
**D**=105,5 MM

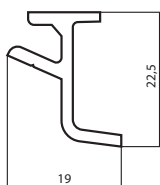
**VP-48130**

**S**=3,653 CM<sup>2</sup>  
**M**=0,990 КГ/М  
**D**=89 MM

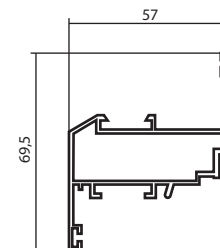
**VP-48109**

**S**=3,627 CM<sup>2</sup>  
**M**=0,983 КГ/М  
**D**=50 MM

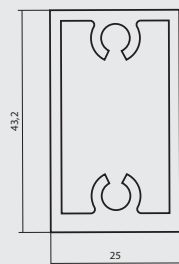
**VPT-60201**

**S**=5,485 CM<sup>2</sup>  
**M**=1,486 КГ/М  
**D**=50,9 MM

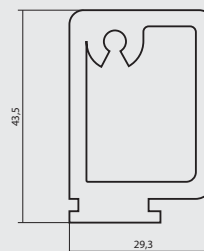
**VP-48110**

**S**=3,31 CM<sup>2</sup>  
**M**=0,897 КГ/М  
**D**=70,8 MM

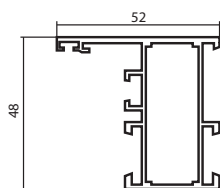
**A-017**

**S**=1,492 CM<sup>2</sup>  
**M**=0,404 КГ/М  
**D**=37 MM

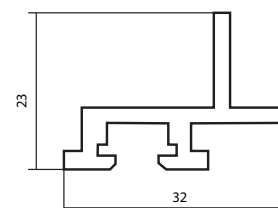
**VP-48122**

**S**=3,779 CM<sup>2</sup>  
**M**=1,024 КГ/М  
**D**=77,8 MM

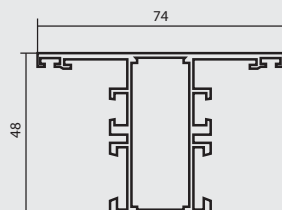
**A-018**

**S**=2,64 CM<sup>2</sup>  
**M**=0,715 КГ/М  
**D**=67 MM

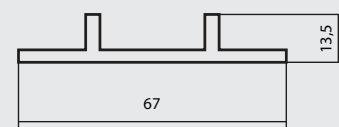

№

**A-019**

**S**=0,965 CM<sup>2</sup>  
**M**=0,946 КГ/М  
**D**=127 MM

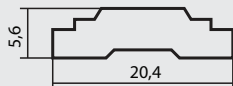
**A-188**

**S**=1,14 CM<sup>2</sup>  
**M**=0,31 КГ/М  
**D**=43 MM

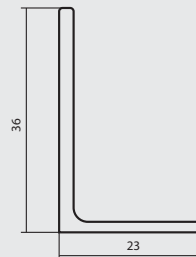
**A-020**

**S**=0,655 CM<sup>2</sup>  
**M**=0,155 КГ/М  
**D**=105,5 MM

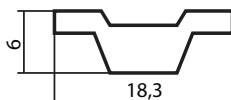
**A-**

**S**=2,01 CM<sup>2</sup>  
**M**=0,54 КГ/М  
**D**=50 MM

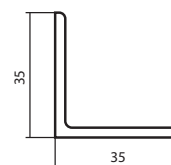
**A-022**

**S**=7,145 CM<sup>2</sup>  
**M**=1,936 КГ/М  
**D**=92 MM

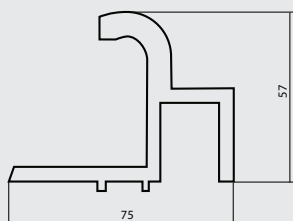
**A-318**

**S**=1,85 CM<sup>2</sup>  
**M**=0,50 КГ/М  
**D**=50 MM

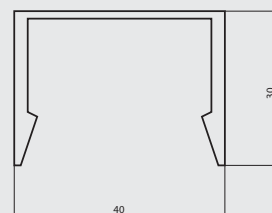
**A-138**

**S**=2,91 CM<sup>2</sup>  
**M**=0,79 КГ/М  
**D**=136 MM

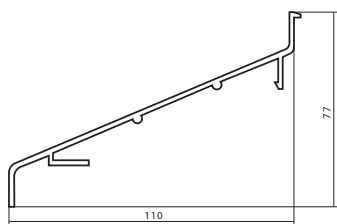
**A-319**

**S**=0,85 CM<sup>2</sup>  
**M**=0,23 КГ/М  
**D**=41 MM

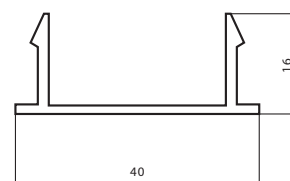
**A-153**

**S**=1,846 CM<sup>2</sup>  
**M**=0,50 КГ/М  
**D**=54 MM

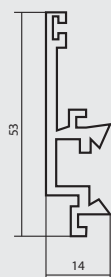
**A-382**

**S**=3,548 CM<sup>2</sup>  
**M**=0,97 КГ/М  
**D**=130 MM

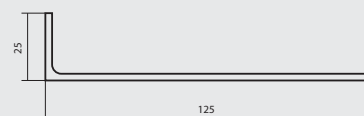

№

**A-1820**

**S**=0,657 CM<sup>2</sup>  
**M**=0,178 КГ/М  
**D**=20,93 MM

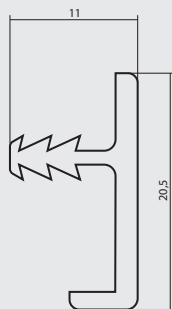
**A-2109**

**S**=3,49 CM<sup>2</sup>  
**M**=0,946 КГ/М  
**D**=127 MM

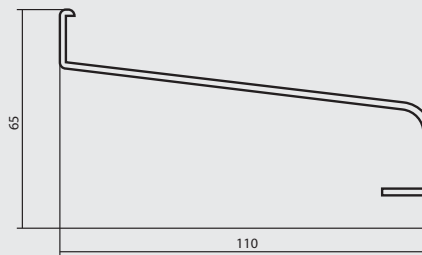
**A-1863**

**S**=0,428 CM<sup>2</sup>  
**M**=0,116 КГ/М  
**D**=15,1 MM

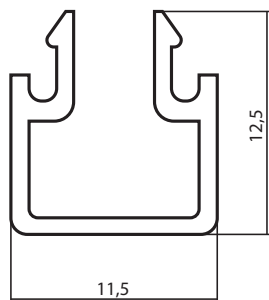
**A-2113**

**S**=4,376 CM<sup>2</sup>  
**M**=1,186 КГ/М  
**D**=172 MM

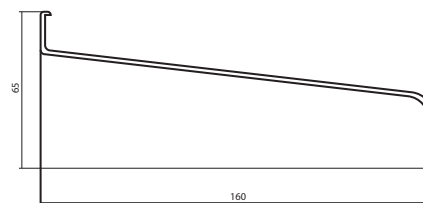
**A-2096**

**S**=1,881 CM<sup>2</sup>  
**M**=0,51 КГ/М  
**D**=66,1 MM

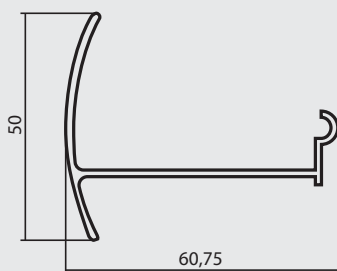
**A-2114**

**S**=1,062 CM<sup>2</sup>  
**M**=0,288 КГ/М  
**D**=33 MM

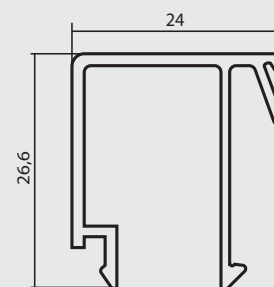
**A-2100**

**S**=1,166 CM<sup>2</sup>  
**M**=0,316 КГ/М  
**D**=38,6 MM

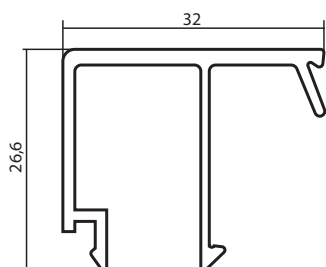
**Б-023К**

**S**=9,21 CM<sup>2</sup>  
**M**=2,495 КГ/М  
**D**=96 MM

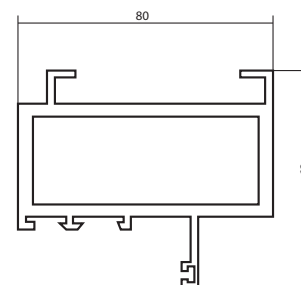
**A-2107**

**S**=0,795 CM<sup>2</sup>  
**M**=0,215 КГ/М  
**D**=36 MM

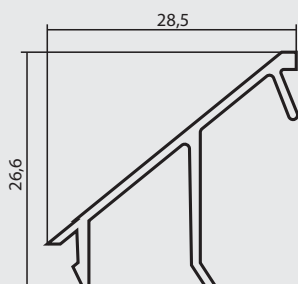
**Б-025**

**S**=4,114 CM<sup>2</sup>  
**M**=1,115 КГ/М  
**D**=77 MM

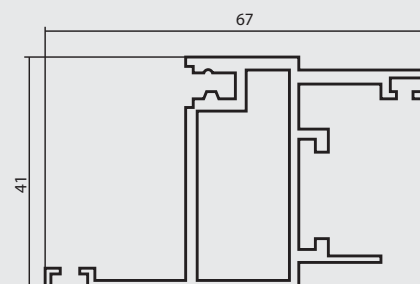

№

**A-427**

**S**=1,62 CM<sup>2</sup>  
**M**=0,455 КГ/М  
**D**=68 MM

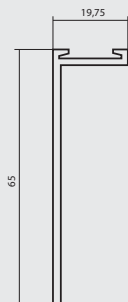
**A-687**

**S**=1,62 CM<sup>2</sup>  
**M**=0,44 КГ/М  
**D**=50 MM

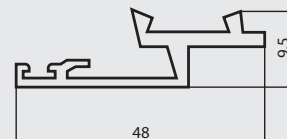
**A-676**

**S**=3,34 CM<sup>2</sup>  
**M**=0,90 КГ/М  
**D**=70 MM

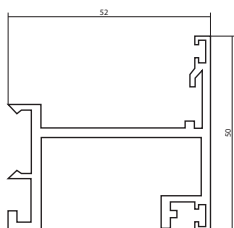
**A-694**

**S**=1,01 CM<sup>2</sup>  
**M**=0,274 КГ/М  
**D**=33 MM

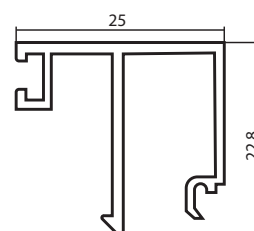
**A-677**

**S**=0,70 CM<sup>2</sup>  
**M**=0,19 КГ/М  
**D**=27 MM

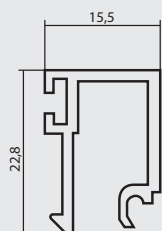
**A-700**

**S**=2,36 CM<sup>2</sup>  
**M**=0,639 КГ/М  
**D**=36,5 MM

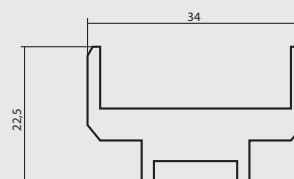
**A-682**

**S**=1,21 CM<sup>2</sup>  
**M**=0,327 КГ/М  
**D**=46 MM

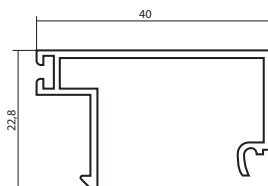
**A-702**

**S**=1,82 CM<sup>2</sup>  
**M**=0,49 КГ/М  
**D**=50 MM

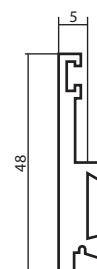
**A-684**

**S**=2,35 CM<sup>2</sup>  
**M**=0,637 КГ/М  
**D**=67 MM

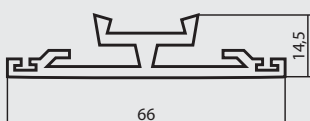
**A-703**

**S**=2,18 CM<sup>2</sup>  
**M**=0,59 КГ/М  
**D**=67 MM

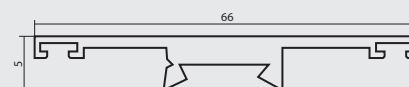

№

**A-797**

**S**=1,84 CM<sup>2</sup>  
**M**=0,499 КГ/М  
**D**=69 MM

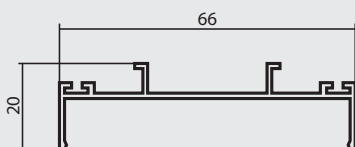
**A-829**

**S**=4,31 CM<sup>2</sup>  
**M**=1,168 КГ/М  
**D**=74 MM

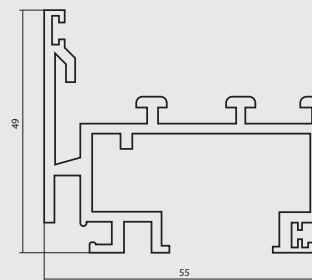
**A-798**

**S**=2,55 CM<sup>2</sup>  
**M**=0,69 КГ/М  
**D**=102 MM

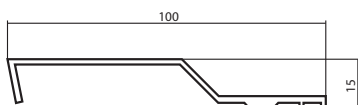
**A-830**

**S**=2,85 CM<sup>2</sup>  
**M**=0,77 КГ/М  
**D**=52 MM

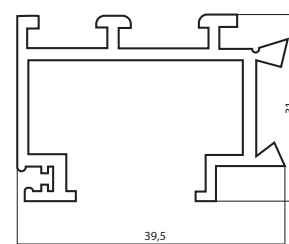
**A-799**

**S**=1,15 CM<sup>2</sup>  
**M**=0,31 КГ/М  
**D**=52 MM

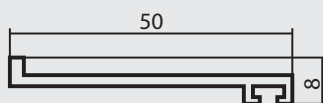
**A-898**

**S**=8,86 CM<sup>2</sup>  
**M**=1,59 КГ/М  
**D**=72 MM

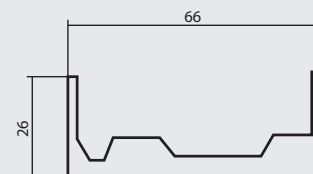
**A-800**

**S**=1,48 CM<sup>2</sup>  
**M**=0,4 КГ/М  
**D**=54 MM

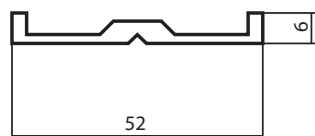
**A-899**

**S**=1,45 CM<sup>2</sup>  
**M**=0,393 КГ/М  
**D**=51 MM

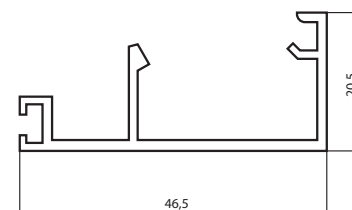
**A-809**

**S**=3,75 CM<sup>2</sup>  
**M**=1,016 КГ/М  
**D**=74 MM

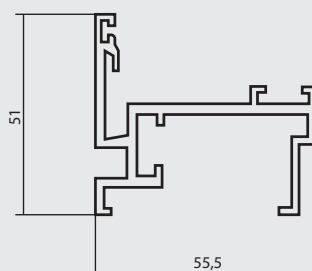
**A-914**

**S**=3,02 CM<sup>2</sup>  
**M**=0,818 КГ/М  
**D**=107 MM

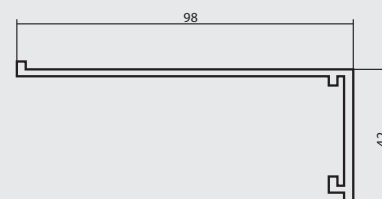



№

**A-797**

**S**=1,84 CM<sup>2</sup>  
**M**=0,499 КГ/М  
**D**=69 MM

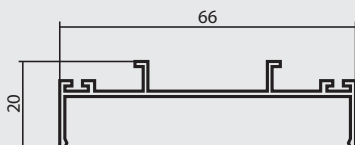
**A-829**

**S**=4,31 CM<sup>2</sup>  
**M**=1,168 КГ/М  
**D**=74 MM

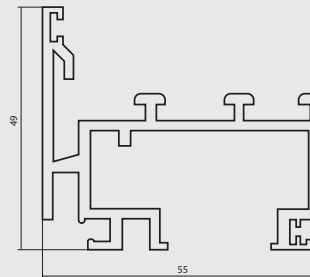
**A-798**

**S**=2,55 CM<sup>2</sup>  
**M**=0,69 КГ/М  
**D**=102 MM

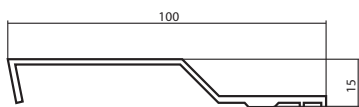
**A-830**

**S**=2,85 CM<sup>2</sup>  
**M**=0,77 КГ/М  
**D**=52 MM

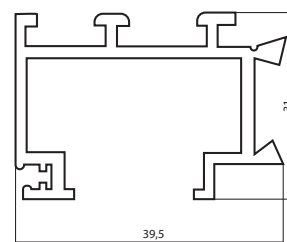
**A-799**

**S**=1,15 CM<sup>2</sup>  
**M**=0,31 КГ/М  
**D**=52 MM

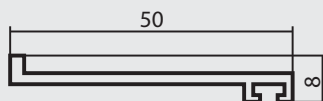
**A-898**

**S**=8,86 CM<sup>2</sup>  
**M**=1,59 КГ/М  
**D**=72 MM

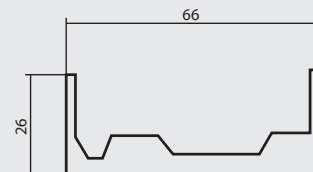
**A-800**

**S**=1,48 CM<sup>2</sup>  
**M**=0,4 КГ/М  
**D**=54 MM

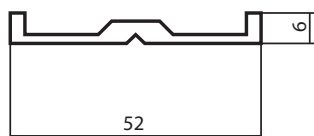
**A-899**

**S**=1,45 CM<sup>2</sup>  
**M**=0,393 КГ/М  
**D**=51 MM

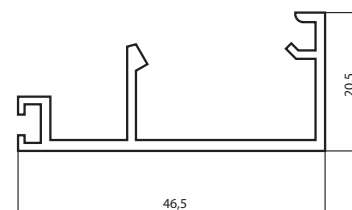
**A-809**

**S**=3,75 CM<sup>2</sup>  
**M**=1,016 КГ/М  
**D**=74 MM

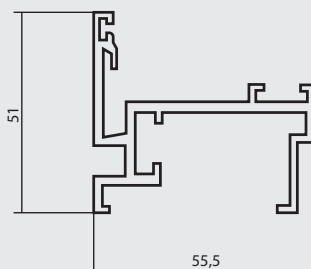
**A-914**

**S**=3,02 CM<sup>2</sup>  
**M**=0,818 КГ/М  
**D**=107 MM

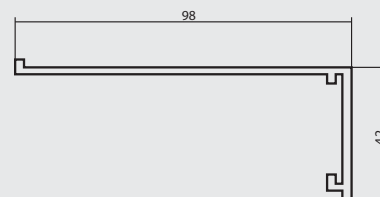

№

**A-915**

**S**=4,75 CM<sup>2</sup>  
**M**=1,287 КГ/М  
**D**=155 MM

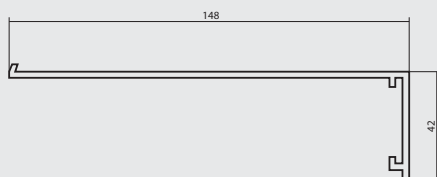
**A-920**

**S**=1,438 CM<sup>2</sup>  
**M**=0,390 КГ/М  
**D**=62 MM

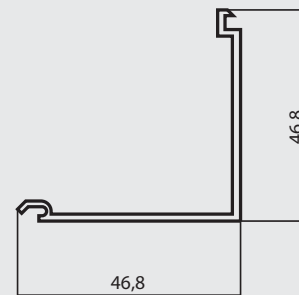
**A-916**

**S**=2,98 CM<sup>2</sup>  
**M**=0,808 КГ/М  
**D**=86 MM

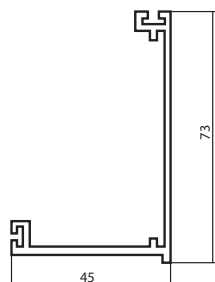
**A-921**

**S**=3,218 CM<sup>2</sup>  
**M**=0,872 КГ/М  
**D**=76 MM

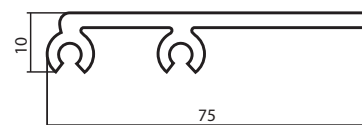
**A-917**

**S**=2,54 CM<sup>2</sup>  
**M**=0,688 КГ/М  
**D**=75 MM

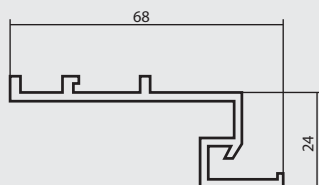
**A-956**

**S**=1,87 CM<sup>2</sup>  
**M**=0,507 КГ/М  
**D**=51 MM

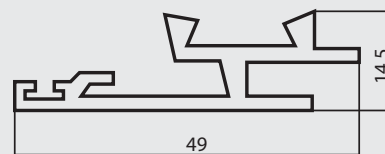
**A-918**

**S**=5,592 CM<sup>2</sup>  
**M**=1,516 КГ/М  
**D**=115 MM

**A-967**

**S**=2,55 CM<sup>2</sup>  
**M**=0,69 КГ/М  
**D**=38 MM

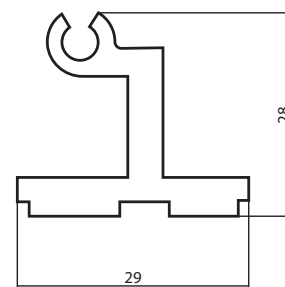
**A-919**

**S**=2,37 CM<sup>2</sup>  
**M**=0,642 КГ/М  
**D**=71 MM

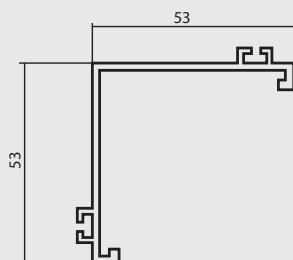
**A-1019**

**S**=5,7 CM<sup>2</sup>  
**M**=1,54 КГ/М  
**D**=70 MM

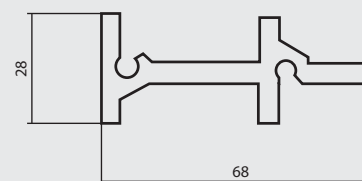

№

**Б-045И**

**S**=3,08 CM<sup>2</sup>  
**M**=0,83 КГ/М  
**D**=47 MM

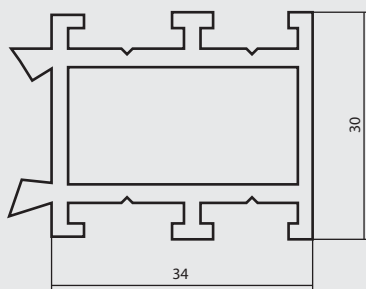
**Б-221**

**S**=8,55 CM<sup>2</sup>  
**M**=2,32 КГ/М  
**D**=90 MM

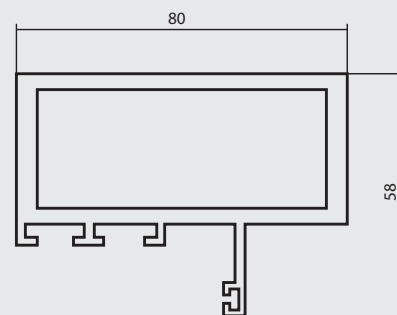
**Б-046**

**S**=5,74 CM<sup>2</sup>  
**M**=1,554 КГ/М  
**D**=99 MM

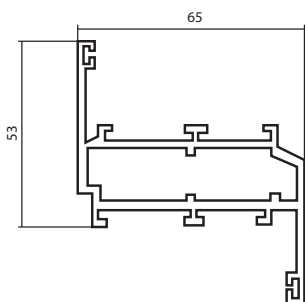
**Б-223**

**S**=11,21 CM<sup>2</sup>  
**M**=3,04 КГ/М  
**D**=126 MM

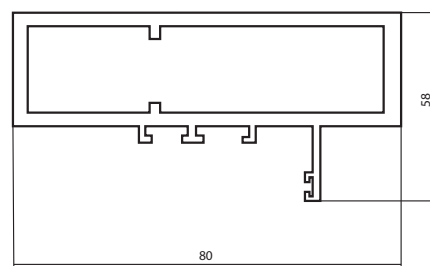
**Б-214**

**S**=4,46 CM<sup>2</sup>  
**M**=1,21 КГ/М  
**D**=82 MM

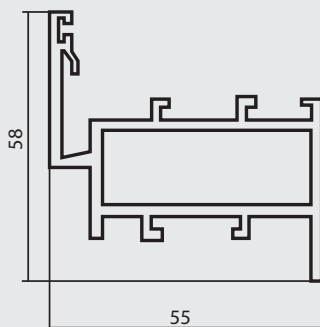
**Б-225**

**S**=11,17 CM<sup>2</sup>  
**M**=3,027 КГ/М  
**D**=126 MM

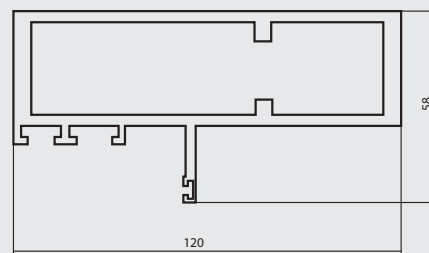
**Б-215**

**S**=5 CM<sup>2</sup>  
**M**=1,355 КГ/М  
**D**=80 MM

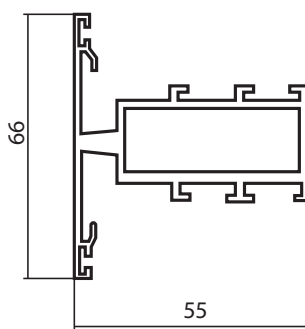
**Б-230**

**S**=6,62 CM<sup>2</sup>  
**M**=1,794 КГ/М  
**D**=89 MM

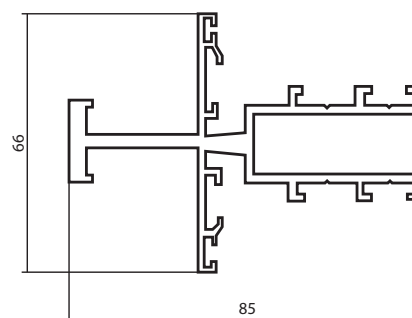
**Б-220**

**S**=9,21 CM<sup>2</sup>  
**M**=2,5 КГ/М  
**D**=92 MM

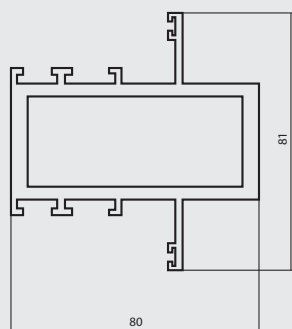
**Б-247**

**S**=3,25 CM<sup>2</sup>  
**M**=0,884 КГ/М  
**D**=51 MM

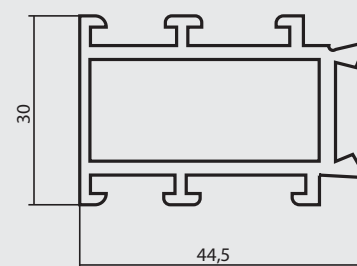

№

**Б-248**

**S**=3,39 CM<sup>2</sup>  
**M**=0,919 КГ/М  
**D**=57,5 MM

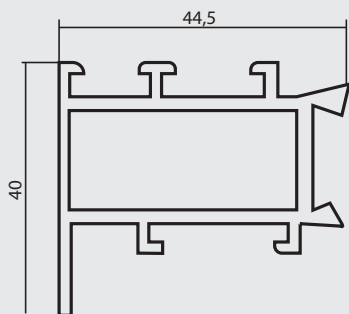
**Б-373**

**S**=3,31 CM<sup>2</sup>  
**M**=0,9 КГ/М  
**D**=51 MM

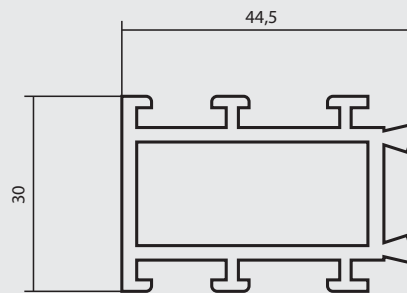
**Б-261**

**S**=11,81 CM<sup>2</sup>  
**M**=32 КГ/М  
**D**=130 MM

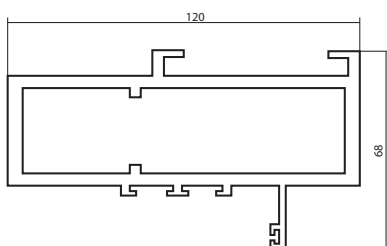
**Б-387**

**S**=4,18 CM<sup>2</sup>  
**M**=1,13 КГ/М  
**D**=72 MM

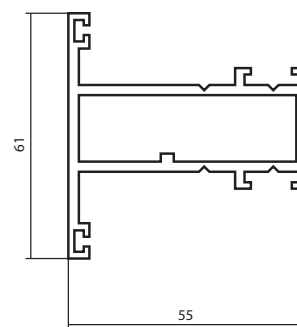
**Б-337**

**S**=9,547 CM<sup>2</sup>  
**M**=2,587 КГ/М  
**D**=126,5 MM

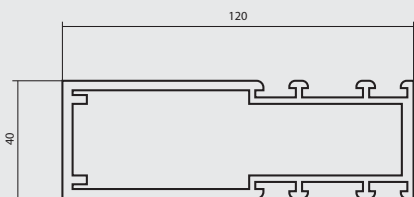
**Б-392**

**S**=2,75 CM<sup>2</sup>  
**M**=0,745 КГ/М  
**D**=47 MM

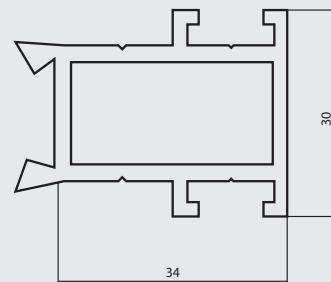
**Б-339**

**S**=8,03 CM<sup>2</sup>  
**M**=2,176 КГ/М  
**D**=117 MM

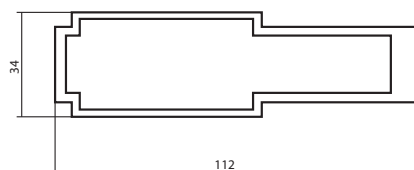
**Б-398**

**S**=4,452 CM<sup>2</sup>  
**M**=1,205 КГ/М  
**D**=82 MM

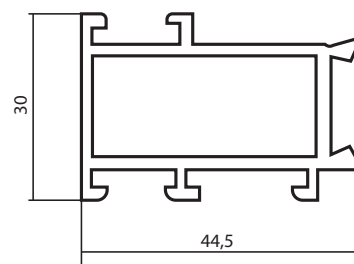
**Б-370**

**S**=5,14 CM<sup>2</sup>  
**M**=1,39 КГ/М  
**D**=79 MM

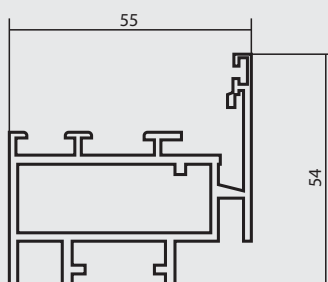
**Б-399**

**S**=4,94 CM<sup>2</sup>  
**M**=1,338 КГ/М  
**D**=80 MM

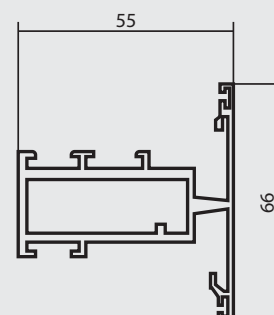

№

**Б-412**

**S**=10,454 CM<sup>2</sup>  
**M**=2,833 КГ/М  
**D**=125 MM

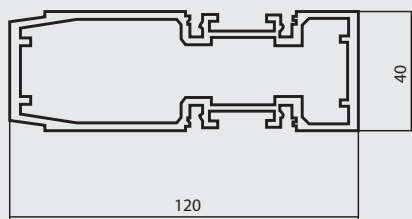
**Б-482**

**S**=6,12 CM<sup>2</sup>  
**M**=1,65 КГ/М  
**D**=103 MM

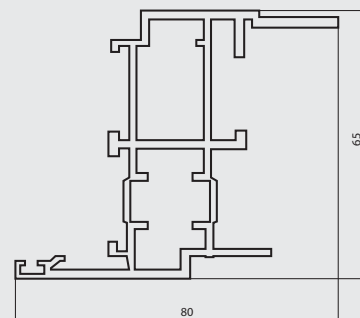
**Б-433**

**S**=1,313 CM<sup>2</sup>  
**M**=0,356 КГ/М  
**D**=16 MM

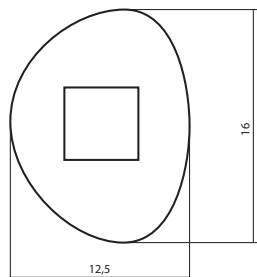
**Б-499**

**S**=3,18 CM<sup>2</sup>  
**M**=0,861 КГ/М  
**D**=71 MM

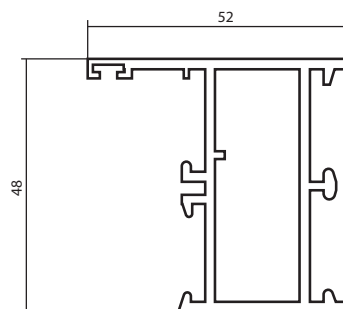
**Б-434**

**S**=8,324 CM<sup>2</sup>  
**M**=2,256 КГ/М  
**D**=96 MM

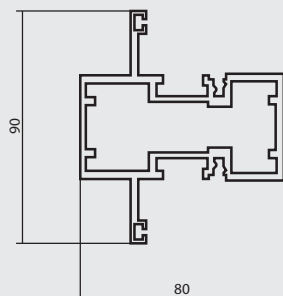
**Б-503**

**S**=1,386 CM<sup>2</sup>  
**M**=0,374 КГ/М  
**D**=45 MM

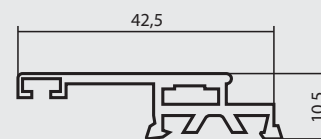
**Б-436**

**S**=10,832 CM<sup>2</sup>  
**M**=2,936 КГ/М  
**D**=147 MM

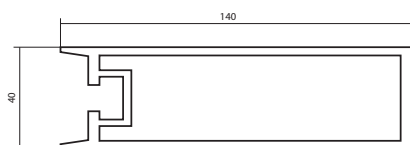
**Б-505**

**S**=14 CM<sup>2</sup>  
**M**=3,8 КГ/М  
**D**=112 MM

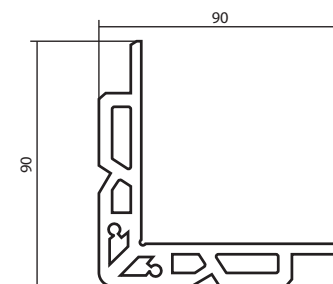
**Б-440**

**S**=3,868 CM<sup>2</sup>  
**M**=1,048 КГ/М  
**D**=70 MM

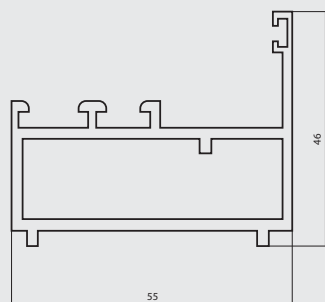
**Б-508**

**S**=3,525 CM<sup>2</sup>  
**M**=0,955 КГ/М  
**D**=73 MM

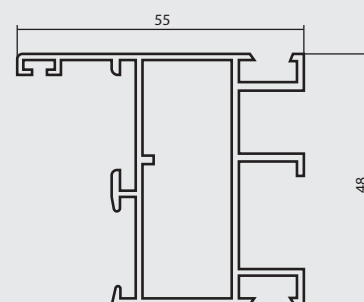

№

**Б-511**

**S**=1,938 CM<sup>2</sup>  
**M**=0,525 КГ/М  
**D**=44 MM

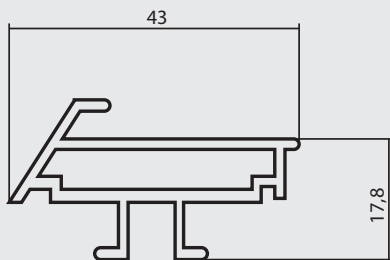
**Б-527**

**S**=2,535 CM<sup>2</sup>  
**M**=0,687 КГ/М  
**D**=57,8 MM

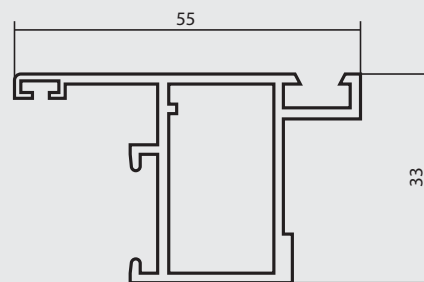
**Б-513**

**S**=8,29 CM<sup>2</sup>  
**M**=2,247 КГ/М  
**D**=130 MM

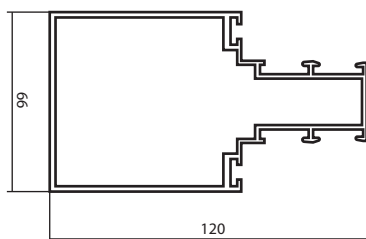
**Б-542**

**S**=2,303 CM<sup>2</sup>  
**M**=0,624 КГ/М  
**D**=41,4 MM

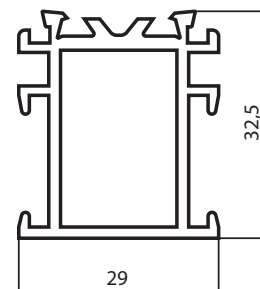
**Б-516**

**S**=7,66 CM<sup>2</sup>  
**M**=2,076 КГ/М  
**D**=123 MM

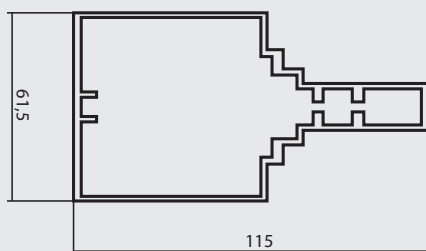
**Б-543**

**S**=2,028 CM<sup>2</sup>  
**M**=0,55 КГ/М  
**D**=65,1 MM

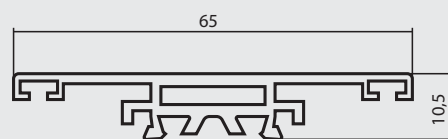
**Б-525**

**S**=3,203 CM<sup>2</sup>  
**M**=0,868 КГ/М  
**D**=76,63 MM

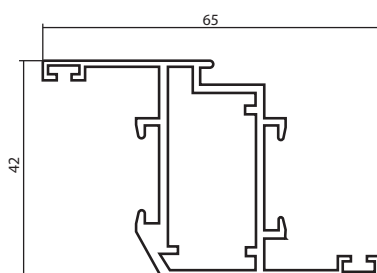
**Б-606**

**S**=3,393 CM<sup>2</sup>  
**M**=0,920 КГ/М  
**D**=62,34 MM

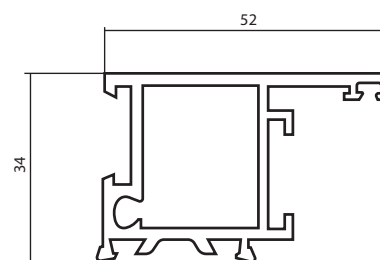
**Б-526**

**S**=2,684 CM<sup>2</sup>  
**M**=0,727 КГ/М  
**D**=64 MM

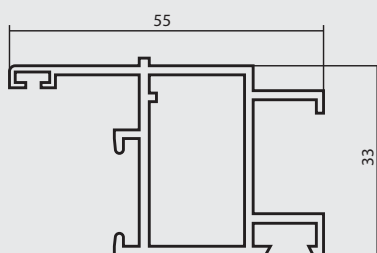
**Б-614**

**S**=4,699 CM<sup>2</sup>  
**M**=1,273 КГ/М  
**D**=110,1 MM

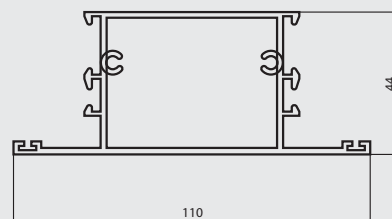

№

**Б-618**

**S**=3,361 CM<sup>2</sup>  
**M**=0,909 КГ/М  
**D**=90 MM

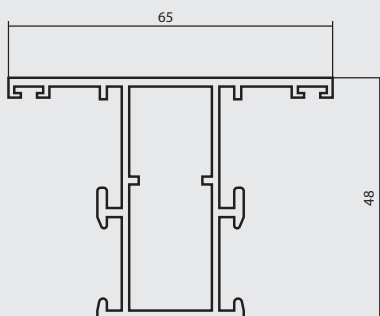
**Б-766**

**S**=0,945 CM<sup>2</sup>  
**M**=0,256 КГ/М  
**D**=32 MM

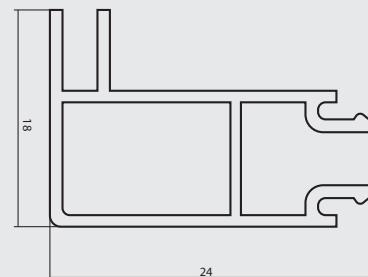
**Б-619**

**S**=2,716 CM<sup>2</sup>  
**M**=0,736 КГ/М  
**D**=66 MM

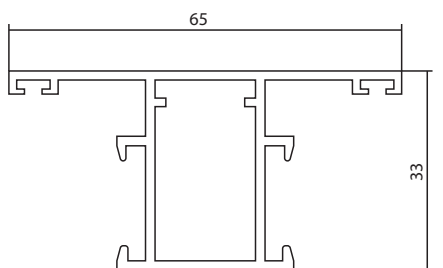
**Б-738**

**S**=0,732 CM<sup>2</sup>  
**M**=0,198 КГ/М  
**D**=24,9 MM

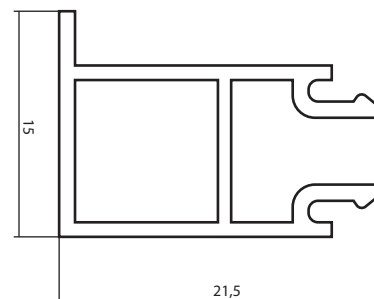
**Б-644**

**S**=0,468 CM<sup>2</sup>  
**M**=0,126 КГ/М  
**D**=17 MM

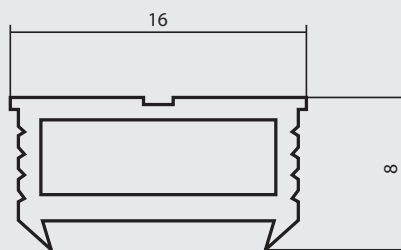
**Б-1010**

**S**=2,384 CM<sup>2</sup>  
**M**=0,646 КГ/М  
**D**=45,2 MM

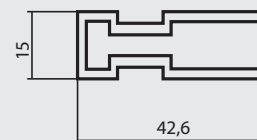
**Б-668**

**S**=2,12 CM<sup>2</sup>  
**M**=0,574 КГ/М  
**D**=42 MM

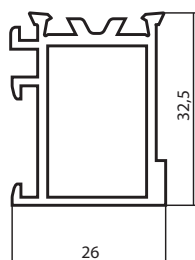
**Б-1033**

**S**=3,194 CM<sup>2</sup>  
**M**=0,865 КГ/М  
**D**=60 MM

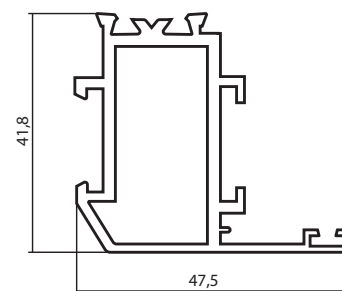
**Б-704**

**S**=4,203 CM<sup>2</sup>  
**M**=1,139 КГ/М  
**D**=90,7 MM

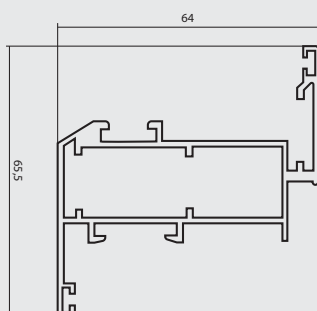
**Б-1034**

**S**=1,850 CM<sup>2</sup>  
**M**=0,501 КГ/М  
**D**=48,4 MM

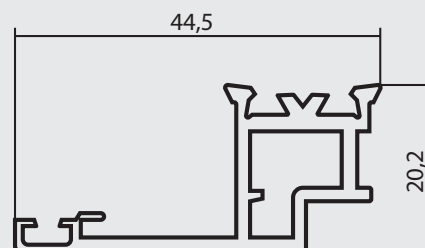

№

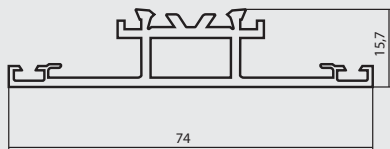
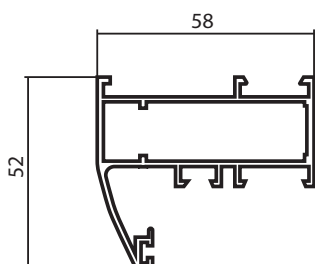
**Б-1037****S**=2,602 CM<sup>2</sup>**M**=0,705 КГ/М**D**=74 MM**Б-1053****S**=3,677 CM<sup>2</sup>**M**=0,996 КГ/М**D**=73 MM**Б-1054****S**=4,429 CM<sup>2</sup>**M**=1,2 КГ/М**D**=77,8 MM